

WE'VE BEEN AROUND.

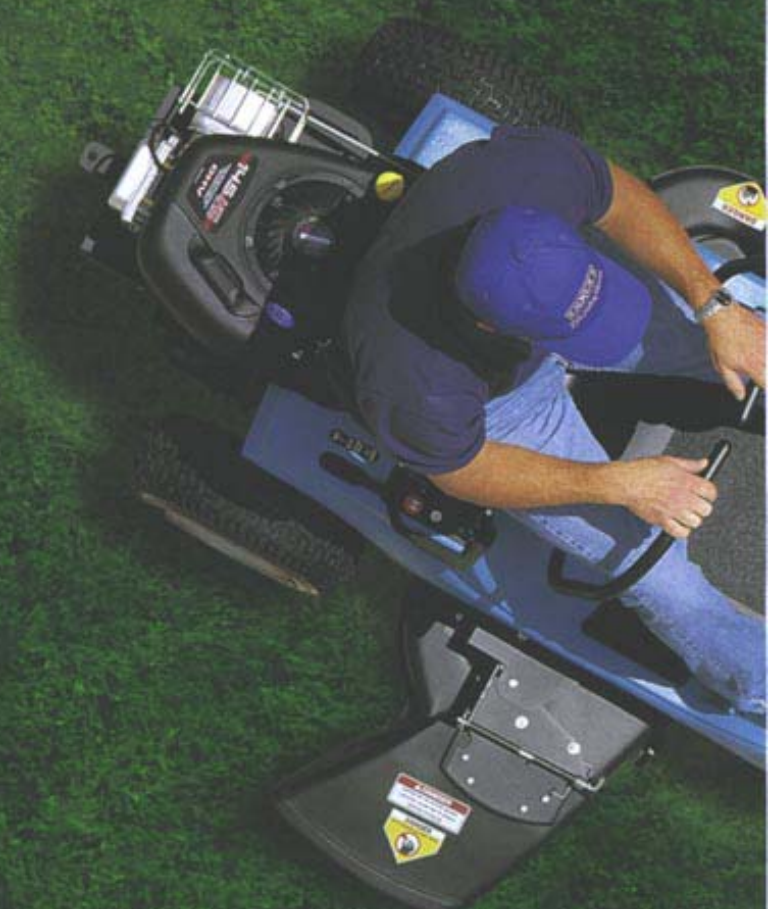

#1 SELLING
Zero Turning Radius Mower!

Dixon ZTR®. For three decades,
the driving force
in zero-turning
residential mowers.

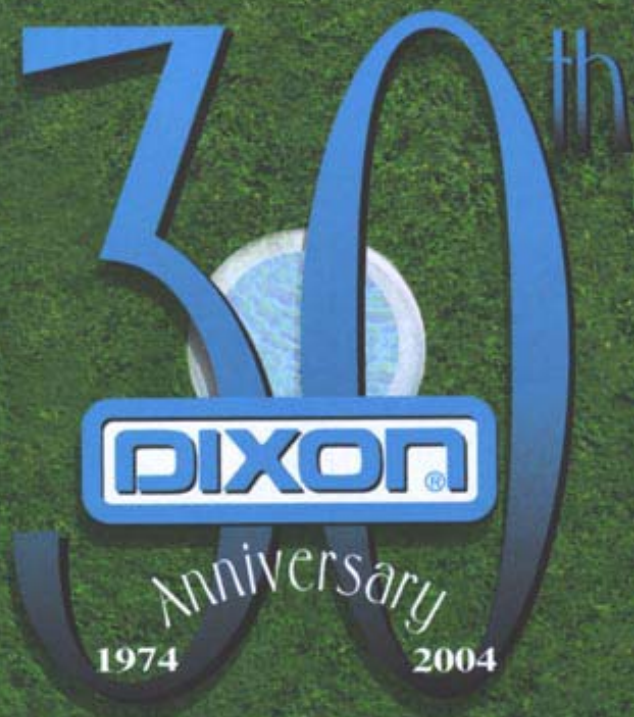

QUALITY CUT

Americans got their first turn on a Dixon ZTR ("zero turning radius") mower 30 years ago. Instantly they recognized what thousands more have discovered since - here's a lawnmower that changes the whole concept of yard "work." On a Dixon, mowing is fun!

- Instead of a steering wheel, Dixon ZTR mowers use two simple steering levers to direct power to the rear drive wheels.
- Gently push or pull the levers and the mower turns on a dime - actually rotates within its own dimensions!
- No more wrestling with the wheel, shifting gears, backing up, or circling the same area again and again.
- Dixon ZTR lets you zip in and out of tight spots, cut up-close around trees and other obstacles, and make square corners and tight circles with one pass.

A Dixon ZTR® not only cuts grass, it can cut your mowing time in half!

Dixon ZTR®

Our success over the past 30 years has made Dixon the "Number One" zero-turning residential mower in America. It's also brought a flood of imitators. But Dixon was born ZTR. And zero-turn mowers are still all we make. Others may try to copy what we do, but the mowers we build today represent the kind of product innovation, manufacturing quality and proven mowing performance that only three decades of experience can produce.

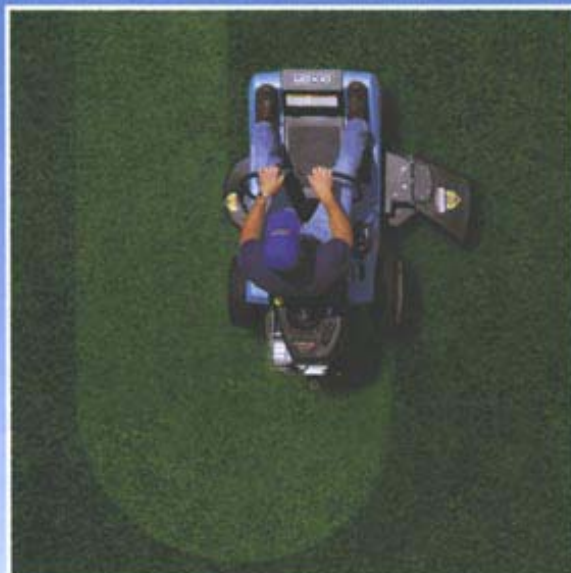

Tighter
turns
means
more
efficient
mowing!

At Dixon, experience has taught us:

- To structurally balance the mowers we build, so they're easier to maneuver and more comfortable to operate
- To design our mowers with a low center of gravity for safer, more stable mowing
- To build them on welded frames for superior strength and durability
- To engineer and patent our own "Z" drive transaxle for true ZTR handling and performance in an affordable package
- To power our heavy duty mowers with proven Hydro-Gear EZT and IZT transmissions
- To build "the industry's best deck" using heavier-gauge components and innovative "tunnel" architecture for improved cutting and discharge
- To structurally integrate our deck and frame for a superior cut
- To incorporate advanced, state-of-the-art features like high-efficiency OHV low-emission engines, maintenance-free batteries, high-density foam seats and electric clutches as standard equipment
- To build mowers so durable we can back them with a Limited Lifetime Warranty on body panels, fenders and frames

Only zero-turning-radius mowers engineered and built to these standards have earned the right to carry the Dixon ZTR® brand.

Warranty

How confident are we of
Dixon ZTR® quality?

We back it for life.

Limited Lifetime Warranty Coverage
Body Panels, Fenders & Frames

FOR THE BEST CUT,
YOU NEED

“THE BEST DECK.”

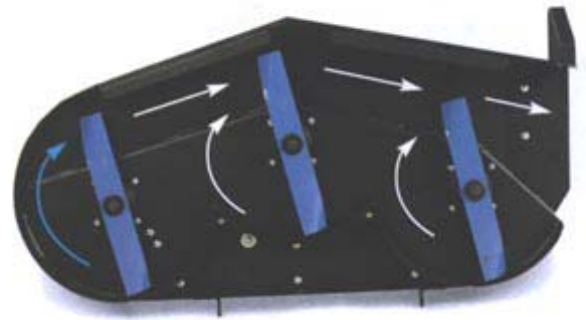

At Dixon we build our mower decks of heavy gauge steel, with cast iron hubs, rugged 1" spindles and precision bearings, temper-hardened steel blades, and single-piece split-steel pulleys (not welded) for maximum durability and strength. Unlike free-floating decks which can react to every little nook or bump in the terrain, Dixon integrates the deck and mower frame -- the cutting plane is dictated by the broad footprint of all four mower wheels, so you get a smoother, more uniform cut. Dixon decks employ an innovative "tunnel" architecture that improves discharge flow, keeps the deck clear of clippings and helps eliminate clumping.

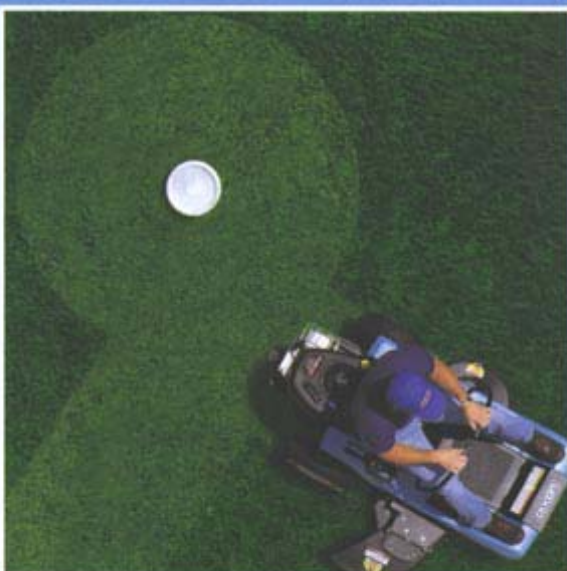

DIXON®

Suburban
Mower

ZEETER —SERIES



ZEETER 30

The **ZEETER®** Why surrender to the drudgery of a conventional mower when genuine Dixon ZTR performance is so affordable? Don't be deceived by its compact size. With your choice of three powerful Briggs and Stratton engines, 30-to-42-inch deck, and legendary Dixon transaxle, the **ZEETER®** runs circles around ordinary mowers. Slip into its foam-cushioned seat and notice how everything (including you!) feels right. Ignition, choke, throttle, blade clutch, 7-position deck height adjustment - they're all within easy reach. A gentle push on the twin steering levers and you're **mowing** places -- maneuvering in an out of tight spots, breezing around trees and obstacles, shaving turf along borders and patios, and shaving time off yard work. But the **ZEETER®** is more than fun and games. Built on a rugged 11-gauge steel frame, it features our durable true-blue polyethylene body that won't dent, ding or rust. And the lighter weight makes it easier on your turf. To make maintenance as effortless as mowing, the **ZEETER®** is designed for easy service access and comes with a maintenance-free battery. A one-piece blade shaft simplifies blade removal.

BRIGGS & STRATTON



ZEETER 42"



| Specifications | ZEETER 30" | ZEETER 36" | ZEETER 42" |
|-----------------------------|------------------------------------------|------------------------------------------|------------------------------------------|
| Turning Radius | ZERO | ZERO | ZERO |
| Height of Cut (APPROX.) | 1.5" to 4" | 1.5" to 4" | 1.5" to 4" |
| Width of Cut | 30" 1 BLADE | 36" 2 BLADES | 42" 3 BLADES |
| Width (DEFLECTOR RETRACTED) | 36" | 39" | 46" |
| Overall Width | 38" | 50" | 55" |
| Weight (APPROX.) | 388 lbs. | 434 lbs. | 434 lbs. |
| Tires | Front: 9 x 3.5 x 4 Rear: 16 x 6.5 x 8 | Front: 9 x 3.5 x 4 Rear: 16 x 6.5 x 8 | Front: 9 x 3.5 x 4 Rear: 16 x 6.5 x 8 |
| Blade Clutch | Manual | Electric | Electric |
| Engine | 9-hp Power Built BRIGGS & STRATTON | 11-hp Power Built BRIGGS & STRATTON | 13-hp Power Built BRIGGS & STRATTON |
| Fuel Capacity | .75 gallons (1 TANK) | .75 gallons (1 TANK) | .75 gallons (1 TANK) |
| Drive | Dixon Transaxle | Dixon Transaxle | Dixon Transaxle |

All models feature electric start.
All specifications subject to change without notice.

DIXON[®]

Suburban
Mower

ZEETER HL
— SERIES



ZEETER HL 30

The **ZEETER[®] HL** Who but Dixon could figure a way to put all the strength and stamina of hydrostatic drive into a smaller, easily-affordable zero-turning mower? Presenting the ZEETER[®] HL. Its true-blue dent-and-rust-proof body tells you it's a Dixon, no question. But the beauty of this mower is more than skin deep. With twin hydrostatic transmissions and your choice of muscular 11-, 13- or 14.5-hp Briggs & Stratton I/C engines, the ZEETER[®] HL delivers performance that belies its compact size. Swing-out steering levers make it easy to get on and off the mower. But who wants to get off? Turn the electronic ignition, disengage the brake, gently push the steering levers and the ZEETER[®] HL responds with a zeal that's pure Dixon. Equipped with 30, 36, or 42-inch cutting deck, the ZEETER[®] HL has more moves than a hungry cheetah - cutting up-close and clean around trees and flower beds, turning on a dime, and making quick work of any yard. An optimized belt drive system ensures longer belt life and smoother operation. And a one-piece blade shaft makes it easier to change blades.



ZEETER HL 42"

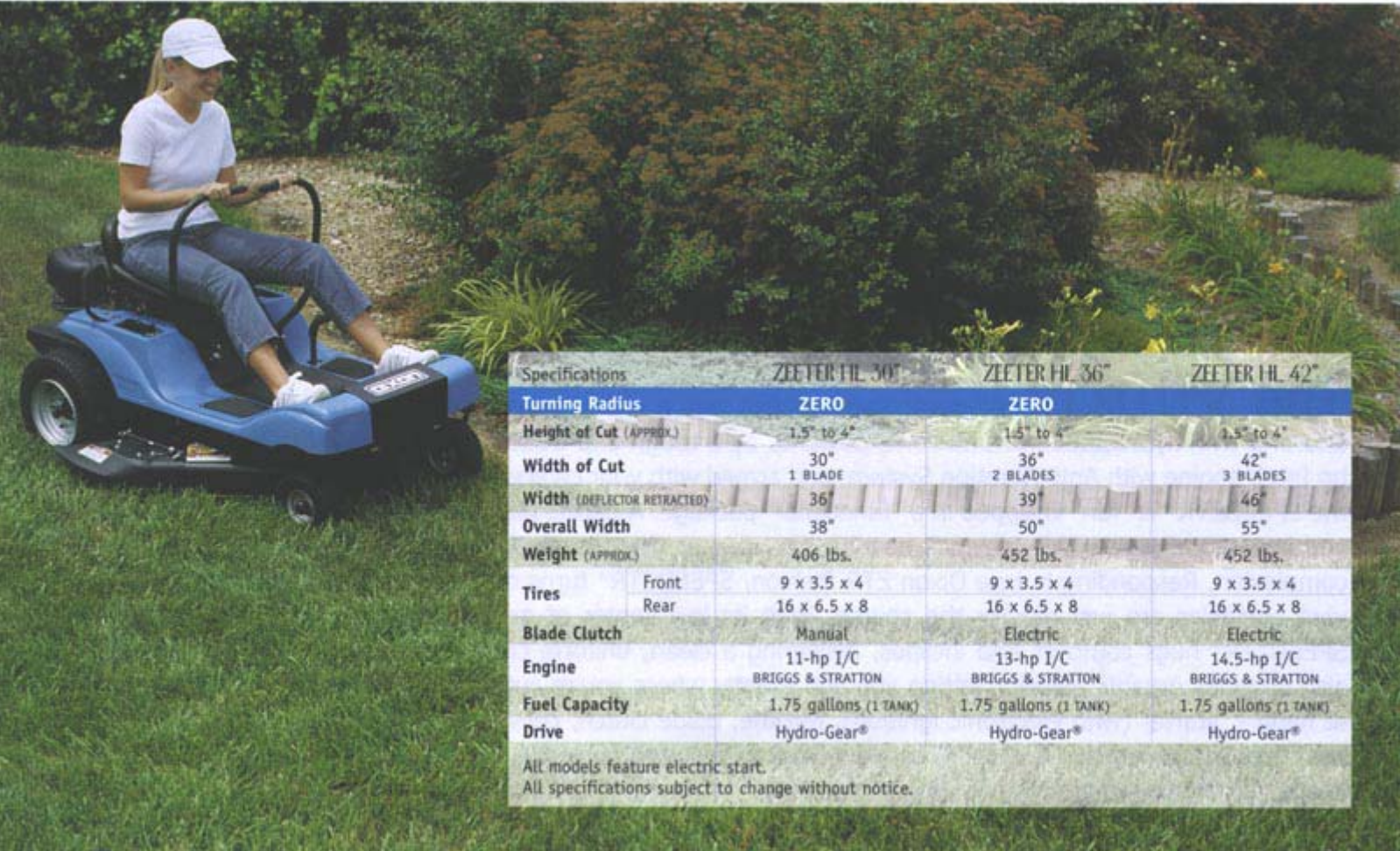

| Specifications | ZEETER HL 30" | ZEETER HL 36" | ZEETER HL 42" |
|-----------------------------|------------------------------------------|------------------------------------------|------------------------------------------|
| Turning Radius | ZERO | ZERO | |
| Height of Cut (APPROX.) | 1.5" to 4" | 1.5" to 4" | 1.5" to 4" |
| Width of Cut | 30" 1 BLADE | 36" 2 BLADES | 42" 3 BLADES |
| Width (DEFLECTOR RETRACTED) | 36" | 39" | 46" |
| Overall Width | 38" | 50" | 55" |
| Weight (APPROX.) | 406 lbs. | 452 lbs. | 452 lbs. |
| Tires | Front: 9 x 3.5 x 4 Rear: 16 x 6.5 x 8 | Front: 9 x 3.5 x 4 Rear: 16 x 6.5 x 8 | Front: 9 x 3.5 x 4 Rear: 16 x 6.5 x 8 |
| Blade Clutch | Manual | Electric | Electric |
| Engine | 11-hp I/C BRIGGS & STRATTON | 13-hp I/C BRIGGS & STRATTON | 14.5-hp I/C BRIGGS & STRATTON |
| Fuel Capacity | 1.75 gallons (1 TANK) | 1.75 gallons (1 TANK) | 1.75 gallons (1 TANK) |
| Drive | Hydro-Gear® | Hydro-Gear® | Hydro-Gear® |

All models feature electric start.
All specifications subject to change without notice.

DIXON®

Estate Mower

SPEEDZTR® —SERIES



SPEEDZTR 36

The SPEEDZTR Whoever said mowing was a chore never had a turn on a Dixon SPEEDZTR®. Sporting twin hydrostatic transmissions, powered by a tough-and-trustworthy Briggs & Stratton 14.5 or 15.5-hp Intek engine with Anti-Vibration System, and armed with your choice of hungry 36 or 42-inch mowing deck, the SPEEDZTR® is "fun" wrapped in a "functional" package. A gentle push on the swing-out control levers and you instantly discover this mower's beauty runs deeper than its sleek styling and blue dent-and-rust-proof complexion. Responding in true Dixon ZTR fashion, SPEEDZTR® turns on a dime -- trees and other traditional yard obstacles are just par for the course. With its low center of gravity and integrated frame and deck, SPEEDZTR® hugs contours and inclines, delivering a clean, uniform cut over the entire yard. Its low profile also provides greater visibility, letting you see exactly where you're cutting at all times. All controls are close at hand - starter (with electronic ignition), throttle, blade clutch, cut-height adjustment, parking brake. And with headlights, 3-gallon fuel tank, comfort-molded seat and convenient cup holder all standard, SPEEDZTR® keeps you mowing and going as long as you like.



SPEEDZTR 36"



| Specifications | | SPEEDZTR 36" | SPEEDZTR 42" |
|------------------------------------|-------|------------------------------------|------------------------------------|
| Turning Radius | | ZERO | ZERO |
| Height of Cut (APPROX.) | | 1.5" to 4" | 1.5" to 4" |
| Width of Cut | | 36" 2 BLADES | 42" 3 BLADES |
| Width (DEFLECTOR RETRACTED) | | 39" | 46" |
| Overall Width | | 50" | 55" |
| Weight (APPROX.) | | 471 lbs. | 471 lbs. |
| Tires | Front | 11 x 4.0 x 5 | 11 x 4.0 x 5 |
| | Rear | 18 x 6.5 x 8 | 18 x 8.5 x 8 |
| Blade Clutch | | Electric | Electric |
| Engine | | 14.5-hp Intek BRIGGS & STRATTON | 15.5-hp Intek BRIGGS & STRATTON |
| Fuel Capacity | | 3 gallons (1 TANK) | 3 gallons (1 TANK) |
| Drive | | Hydro-Gear® | Hydro-Gear® |

All models feature electric start.
All specifications subject to change without notice.

PIXON®

Estate Mower

4500 SERIES



ZTR 4515

The Dixon 4500 ZTR® For people whose yards are measured in "acres" instead of "feet," we offer the proven ability of the Dixon ZTR 4500 series. Here's everything you'd want in a high-performance, low-maintenance zero turning radius mower. A choice of engines including 15.5-hp Briggs & Stratton, or 16- or 18-hp Kohler Command. An industrious 42- or 50-inch precision-balanced deck that consistently delivers a professional looking cut, even following the busiest landscape, or on hillsides and contours. Twin hydrostatic transmissions control the drive wheels independently, giving these mowers their celebrated Dixon ZTR agility. Adjustable, custom-cushioned Cordura seat. Maintenance-free battery. Headlights and side trim lights to extend your mowing time. Plus a full complement of optional Dixon accessories to extend your mower's use. Drawing on three decades of innovations and improvements, the Dixon 4500 models represent some of our best efforts. . . to help you keep your yard beautiful with no effort at all.



Each rear wheel has a self-contained, fan-cooled hydrostatic drive/gearbox for years of maintenance free service.

ZTR 4516



All Dixon hydrostatic drives use cylindrical pistons that seal wet and are less subject to heat and viscosity changes compared to ball-type pistons used by other mower brands.

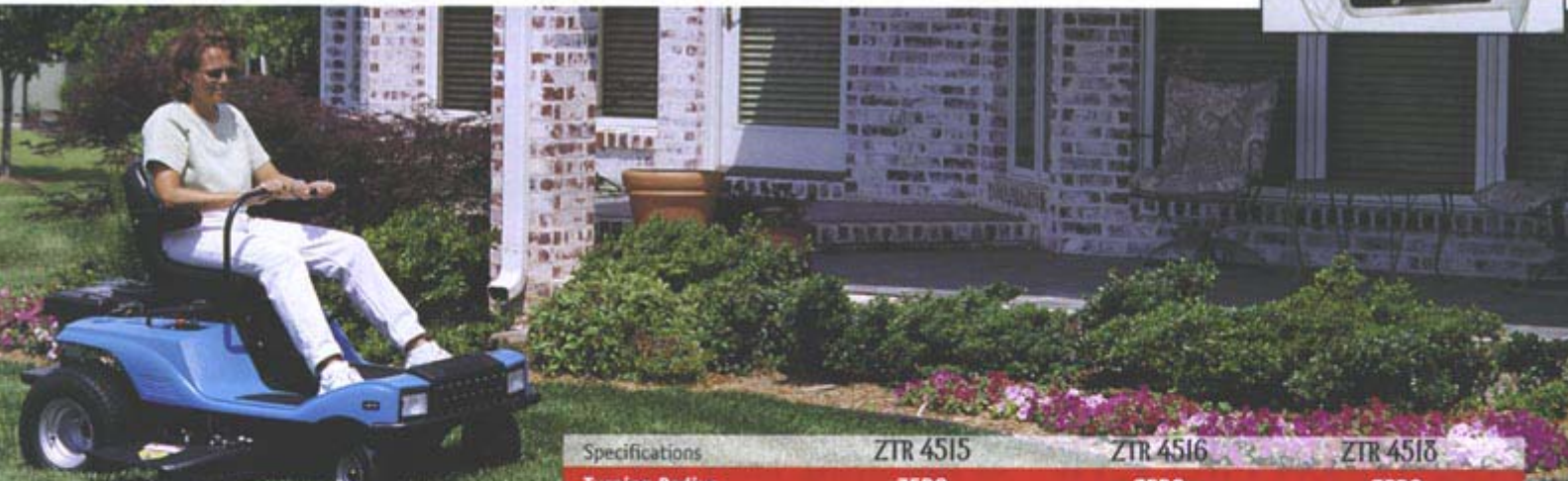
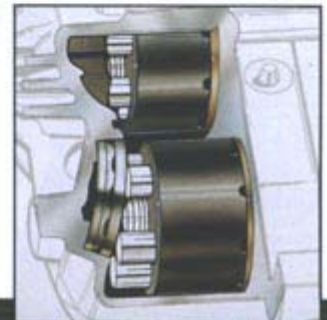

| Specifications | ZTR 4515 | | ZTR 4516 | | ZTR 4518 | |
|-----------------------------|---------------------------------------|------------------------------|-------------------------|------------------------------|----------------------------------|------------------------------|
| Turning Radius | ZERO | | ZERO | | ZERO | |
| Height of Cut (APPROX.) | 1.5" to 3.5" | | 1.5" to 3.5" | | 1.5" to 3.5" | |
| Width of Cut | 42" 3 BLADES | 50" 3 BLADES | 42" 3 BLADES | 50" 3 BLADES | 42" 3 BLADES | 50" 3 BLADES |
| Width (DEFLECTOR RETRACTED) | 46" | 51" | 46" | 51" | 46" | 51" |
| Overall Width | 55" | 60" | 55" | 60" | 55" | 60" |
| Weight (APPROX.) | 568 lbs. | 615 lbs. | 568 lbs. | 615 lbs. | 568 lbs. | 618 lbs. |
| Tires | Front Rear | 11 x 4.0 x 5 18 x 8.5 x 8 | Front Rear | 11 x 4.0 x 5 18 x 8.5 x 8 | Front Rear | 11 x 4.0 x 5 18 x 8.5 x 8 |
| Blade Clutch | Electric | | Electric | | Electric | |
| Engine | 15.5-hp Vanguard BRIGGS & STRATTON | | 16-hp Kohler COMMAND | | 18-hp Twin Kohler COMMAND PRO | |
| Fuel Capacity | 2.7 gallons (1 TANK) | | 2.7 gallons (1 TANK) | | 2.7 gallons (1 TANK) | |
| Drive | Hydro-Gear® | | Hydro-Gear® | | Hydro-Gear® | |



All models feature electric start.
All specifications subject to change without notice.

DIXON®

Pro Mower

PRO ZTR SERIES



PRO ZTR 1950

The Dixon PRO ZTR® All new styling, heavy duty welded construction, and a long list of commercial features make our new PRO ZTR models the choice of folks who take their yard work seriously. Dixon's PRO 1950 uses a healthy 19-hp commercial grade Kawasaki engine to drive our rugged 50-inch precision-built cutting deck. Need more power? Choose the 23-hp Twin Kohler Command Pro-powered PRO 2300, available with your choice of 50- or 60-inch deck. Both models feature commercial-style hydro transmissions (with pump and wheel motors), heavy duty yoke-type front axles, oversized saddle fuel tanks, and "big-rig"-style seat suspension. The seat and floorboard flip-up for easy service access. As nimble as they are durable, these models display legendary Dixon dexterity even with our impressive 4-or-5 foot cutting decks in tow. A touch of the control levers, and the mower responds instantly -- almost instinctively -- making quick 180-turns, square corners and tight circles, and whisking you over landscape and through yard work with time to spare. Climb aboard one of these agile beasts and watch the time and turf fly by.

Exclusive Dixon "Big Rig" Seal Suspension



Seat and floor board flip-up for easy service access.



PRO ZTR 2300



50"



60"

| Specifications | PRO ZTR 1950 | PRO ZTR 2300 |
|------------------------------------|----------------------------------------|----------------------------------|
| Turning Radius | ZERO | ZERO |
| Height of Cut (APPROX.) | 1.5" to 4.5" | 1.5" to 4.5" |
| Width of Cut | 50" 3 BLADES | 60" 3 BLADES |
| Width (DEFLECTOR RETRACTED) | 51" | 63" 51" |
| Overall Width | 60" | 73" 60" |
| Weight (APPROX.) | 737 lbs. | 770 lbs. 737 lbs. |
| Tires | Front 11 x 4.0 x 5 Rear 20 x 10 x 8 | 11 x 4.0 x 5 20 x 10 x 8 |
| Blade Clutch | Electric | Electric |
| Engine | 19-hp Twin FH Series KAWASAKI | 23-hp Twin Kohler COMMAND PRO |
| Fuel Capacity | 11.5 gallons (2 TANKS) | 11.5 gallons (2 TANKS) |
| Drive | Hydro-Gear®/White | Hydro-Gear®/White |

All models feature electric start.
All specifications subject to change without notice.

DIXON®

Pro Mower

2560



ZTR 2560

The Pro ZTR 2560 uses wheel motors for the final drive.



Specifications

PRO ZTR 2560

| Turning Radius | | ZERO |
|-----------------------------|-------|-------------------------------|
| Height of Cut (Approx.) | | 1.5" to 5" |
| Width of Cut | | 60" 3 blades |
| Width (Deflector Retracted) | | 62.5" |
| Overall Width | | 73.5" |
| Weight (Approx.) | | 1,117 lbs. |
| Tires | Front | 13 x 5.0 x 6 |
| | Rear | 23 x 9.5 x 12 |
| Blade Clutch | | Electric |
| Engine | | 25-hp Twin Kohler Command Pro |
| Fuel Capacity | | 11 gallons (1 tank) |
| Drive | | Hydro-Gear®/White |

All models feature electric start.

All specifications subject to change without notice.

The Dixon 2560 ZTR® Our Dixon PRO ZTR 2560 hits the ground running with an unbeatable combination of industrial-strength cutting power and famed Dixon ZTR agility. A professional grade mower built for the residential market, the Pro 2560 is precision-built on a frame of heavy 10-gauge steel, using 7-gauge steel as reinforcement. The 2560 is powered by a muscular 25-hp Twin Kohler Command Pro engine and features heavy duty fan-cooled commercial grade hydro-transmissions (with pump and wheel motors). It's voracious 60-inch mid-mount full-floating cutting deck employs three tempered-steel blades and Dixon's innovative "tunnel" technology for cleaner, more efficient cutting and discharge. From the seated position, the operator can easily adjust the cutting height using our "positive-lock" 9-position deck height control. Even the biggest jobs are just part of a day's work for the PRO 2560. The added seat suspension and an industrial-style non-skid dimpled foot pan are designed to keep the operator as relaxed as the mower itself, and in total control at all times.

DIXON®

Pro Mower

2700



PRO 2700



Specifications

PRO ZTR 2700

| Turning Radius | | ZERO | |
|-----------------------------|-------|--------------------------------------------|-----------|
| Height of Cut (APPROX.) | | 1.5" to 6" | |
| Width of Cut | | 60" | 72" |
| | | 3 BLADES | 3 BLADES |
| Width (DEFLECTOR RETRACTED) | | 62.5" | 74.5" |
| Overall Width | | 73.5" | 85.5" |
| Weight (APPROX.) | | 1131 lbs. | 1161 lbs. |
| Tires | Front | 13 x 6.5 x 6 | |
| | Rear | 23 x 10.5 x 12 | |
| Blade Clutch | | Electric | |
| Engine | | 27-hp Twin Kawasaki LIQUID COOLED - GAS | |
| Fuel Capacity | | 11.5 gallons (2 TANKS) | |
| Drive | | Hydro-Gear®/White | |

All models feature electric start.
All specifications subject to change without notice.

The Dixon 2700 ZTR® Our engineers brought together the latest technical advancements and the greatest Dixon features and packed them all into a grass-hungry beast we call the PRO ZTR 2700. We started with a welded-and-reinforced tubular steel frame. To that we added "big rig" shock-absorbing seat suspension, heavy duty yoke-type front axles, big 23" rear tires, and oversized quick-fill saddle fuel tanks. Beneath this brute we suspended your choice of a 60-inch or massive 72-inch precision-engineered free-floating cutting deck. Then to power it all, we added a monster 27-hp twin liquid-cooled Kawasaki gas engine - the choice of professional mowers thanks to its high horse power, high torque and proven stamina. Make no mistake, the PRO 2700 is all business. Fire it up and you can almost see the grass start to shrink.



ZTR Accessories

To get the most from your equipment investment, Dixon offers a full line of accessories. Depending on the mower model you choose, you'll find optional attachments and accessories to speed up your mowing even more, to help with other jobs around the yard, or to customize your mower for your individual needs. Thanks to Dixon's independently-controlled drive wheels, your mower can be as effective scraping snow off the drive as it is cutting grass in the yard!



Snow Blade



Snow Blower



Mulching Kits



Assist Bar



Handy Lever



Mower Cover

Collection Systems



Not all attachments are available for all mowers. Please consult your dealer.

Suburban

ZEETER 30

ZEETER 36

ZEETER 42

ZEETER HL 30

ZEETER HL 36

| ENGINE | Briggs & Stratton | Briggs & Stratton | Briggs & Stratton | Briggs & Stratton | Briggs & Stratton |
|----------------------------------|--------------------------------------|--------------------------------------|--------------------------------------|--------------------------------------|--------------------------------------|
| Type | Powerbuilt | Powerbuilt | Powerbuilt | I/C | I/C |
| Horsepower @ 3600 RPM | 9 | 11 | 13 | 11 | 13 |
| Cylinders | 1 | 1 | 1 | 1 | 1 |
| Displacement cc (cu. in.) | 465 cc (28.4 cu. in.) | 465 cc (28.4 cu. in.) | 465 cc (28.4 cu. in.) | 344 cc (21.0 cu. in.) | 465 cc (28.4 cu. in.) |
| Bore x Stroke mm (in.) | 87.3 mm x 77.7 mm (3.44" x 3.06") | 87.3 mm x 77.7 mm (3.44" x 3.06") | 87.3 mm x 77.7 mm (3.44" x 3.06") | 87.3 mm x 57.6 mm (3.44" x 2.27") | 87.3 mm x 77.7 mm (3.44" x 3.06") |
| Cast Iron Sleeve | Yes | Yes | Yes | Yes | Yes |
| Oil Capacity | 1.3 qts. | 1.3 qts. | 1.3 qts. | 1.3 qts. | 1.3 qts. |
| Lubrication | Splash Lube | Splash Lube | Splash Lube | Splash Lube | Splash Lube |
| Oil Filter | None | None | None | None | None |
| Air Cleaner | Paper Element w/foam precleaner | Paper Element w/foam precleaner | Paper Element w/foam precleaner | Paper Element w/foam precleaner | Paper Element w/foam precleaner |
| Ignition | Electronic | Electronic | Electronic | Electronic | Electronic |
| Starter | 12 V. w/key & solenoid | 12 V. w/key & solenoid | 12 V. w/key & solenoid | 12 V. w/key & solenoid | 12 V. w/key & solenoid |
| Electrical System | 3 amp DC regulated | 9 amp DC regulated | 9 amp DC regulated | 3 amp DC regulated | 9 amp DC regulated |
| Interlock Safety Switch | Seat/Brake/Mower | Seat/Brake/Mower | Seat/Brake/Mower | Seat/Levers/Brake/Mower | Seat/Levers/Brake/Mower |
| Battery | 12 V. / CCA 260 | 12 V. / CCA 260 | 12 V. / CCA 260 | 12 V. / CCA 260 | 12 V. / CCA 260 |
| Fuel Tank Capacity | .75 Gal. | .75 Gal. | .75 Gal. | 1.75 Gal. | 1.75 Gal. |
| Mounting | Solid Mount | Solid Mount | Solid Mount | Solid Mount | Solid Mount |
| TRANSMISSION | | | | | |
| Make | Dixon Transaxle | Dixon Transaxle | Dixon Transaxle | Hydro-Gear | Hydro-Gear |
| Type | Cone Drive | Cone Drive | Cone Drive | EZT | EZT |
| Final Drive | Chain | Chain | Chain | Gear | Gear |
| Forward Speed | 5.5 mph | 5.5 mph | 5.5 mph | 6.0 mph | 6.0 mph |
| Park Brake | Drum | Drum | Drum | Ratchet | Ratchet |
| OTHER FEATURES | | | | | |
| Deck Cut Width | 30" | 36" | 42" | 30" | 36" |
| Deck Width (DEFLECTOR RETRACTED) | 36" | 39" | 46" | 36" | 39" |
| Overall Deck Width | 38" | 50" | 55" | 38" | 50" |
| Number of Blades | 1 | 2 | 3 | 1 | 2 |
| Mower Cutting Height Range | 1.5" to 4" | 1.5" to 4" | 1.5" to 4" | 1.5" to 4" | 1.5" to 4" |
| Mower Cutting Positions | 7 | 7 | 7 | 7 | 7 |
| Deck Weight | 47 lbs. | 93 lbs. | 93 lbs. | 47 lbs. | 93 lbs. |
| Power Unit Weight | 341 lbs. | 341 lbs. | 341 lbs. | 359 lbs. | 359 lbs. |
| Construction | 11 ga. Stamped | 11 ga. Stamped | 11 ga. Stamped | 11 ga. Stamped | 11 ga. Fab |
| Spindle | 1" | 1" | 1" | 1" | 1" |
| Hub | Cast Iron | Cast Iron | Cast Iron | Cast Iron | Cast Iron |
| Anti Scalp Wheels | No | Optional | Optional | No | Optional |
| Steering Control | Twin Lever | Twin Lever | Twin Lever | Twin Lever/Swing Out | Twin Lever/Swing Out |
| Seat Cushion | High Density Foam | High Density Foam | High Density Foam | High Density Foam | High Density Foam |
| Seat Cover | Vinyl | Vinyl | Vinyl | Vinyl | Vinyl |
| Seat Springs | No | No | No | Standard | Standard |
| Beverage Holder | No | No | No | No | No |
| Mower Clutch | Manual | Electric | Electric | Manual | Electric |
| Tires-Front | 9 x 3.5 x 4 | 9 x 3.5 x 4 | 9 x 3.5 x 4 | 9 x 3.5 x 4 | 9 x 3.5 x 4 |
| Tires-Rear | 16 x 6.5 x 8 | 16 x 6.5 x 8 | 16 x 6.5 x 8 | 16 x 6.5 x 8 | 16 x 6.5 x 8 |
| Turning Radius | Zero | Zero | Zero | Zero | Zero |
| WARRANTY | | | | | |
| Homeowner | 2 Years | 2 Years | 2 Years | 2 Years | 2 Years |
| Commercial | 30 Days | 30 Days | 30 Days | 90 Days | 90 Days |
| ACCESSORIES | | | | | |
| Mulching Kit | Yes | Yes | Yes | Yes | Yes |
| Grass Blower | No | Yes | Yes | No | Yes |
| Grass Catcher | Yes | Yes | Yes | Yes | Yes |
| Twin Bag Grass Collector | Yes | Yes | Yes | Yes | Yes |
| Grass Catcher Cart | No | No | No | No | No |
| Clam Shell Grass Catcher | No | No | No | No | No |
| Snow Blower | No | No | No | No | No |
| Snow Blades | No | No | No | Yes | Yes |
| Wheel Weights/Chains | No | No | No | Yes | Yes |

| Briggs & Stratton | ENGINE | Briggs & Stratton | Briggs & Stratton | Briggs & Stratton | Kohler |
|-----------------------------------|----------------------------------|-----------------------------------|-----------------------------------|-----------------------------------|---------------------------------|
| I/C | Type | Intek | Intek | Vanguard | Command |
| 14.5 | Horsepower @ 3600 RPM | 14.5 | 15.5 | 15.5 | 16 |
| 1 | Cylinders | 1 | 1 | 1 | 1 |
| 465 cc (28.4 cu. in.) | Displacement cc (cu. in.) | 465 cc (28.4 cu. in.) | 465 cc (28.4 cu. in.) | 465 cc (28.4 cu. in.) | 460 cc (28.1 cu. in.) |
| 87.3 mm x 77.7 mm (3.44" x 3.06") | Bore x Stroke mm (in.) | 87.3 mm x 77.7 mm (3.44" x 3.06") | 87.3 mm x 77.7 mm (3.44" x 3.06") | 87.3 mm x 77.7 mm (3.44" x 3.06") | 87 mm x 77 mm (3.42" x 3.03") |
| Yes | Cast Iron Sleeve | Yes | Yes | N/A | N/A |
| 1.3 qts. | Oil Capacity | 1.3 qts. | 1.3 qts. | 1.3 qts. | 2 qts. |
| Splash Lube | Lubrication | Pressure Lube | Pressure Lube | Pressure Lube | Full Pressure Lube |
| None | Oil Filter | Disposable Canister | Disposable Canister | Disposable Canister | Disposable Canister |
| Paper Element w/foam precleaner | Air Cleaner | Paper Element w/foam precleaner | Paper Element w/foam precleaner | Paper Element w/foam precleaner | Paper Element w/foam precleaner |
| Electronic | Ignition | Electronic | Electronic | Electronic | Electronic |
| 12 V. w/key & solenoid | Starter | 12 V. w/key & solenoid | 12 V. w/key & solenoid | 12 V. w/ key & solenoid | 12 V. w/ key & solenoid |
| 9 amp DC regulated | Electrical System | 16 amp DC regulated | 16 amp DC regulated | 16 amp DC regulated | 15 amp DC regulated |
| Seat/Levers/Brake/Mower | Interlock Safety Switch | Seat/Levers/Brake/Mower | Seat/Levers/Brake/Mower | Seat/Traction Drive/Mower | Seat/Traction Drive/Mower |
| 12 V. / CCA 260 | Battery | 12 V. / CCA 260 | 12 V. / CCA 260 | 12 V. / CCA-340 | 12 V. / CCA-340 |
| 1.75 Gal. | Fuel Tank Capacity | 3.0 Gal. | 3.0 Gal. | 2.7 Gal. | 2.7 Gal. |
| Solid Mount | Mounting | Solid Mount | Solid Mount | Solid Mount | Solid Mount |
| TRANSMISSION | | | | | |
| Hydro-Gear | Make | Hydro-Gear | Hydro-Gear | Hydro-Gear | Hydro-Gear |
| EZT | Type | EZT | EZT | IZT | IZT |
| Gear | Final Drive | Gear | Gear | Bevel / Spur Gear | Bevel / Spur Gear |
| 6.0 mph | Forward Speed | 6.5 mph | 6.5 mph | 6.5 mph | 6.5 mph |
| Ratchet | Park Brake | Ratchet | Ratchet | Disc | Disc |
| OTHER FEATURES | | | | | |
| 42" | Deck Cut Width | 36" | 42" | 50" 42" | 50" 42" |
| 46" | Deck Width (DEFLECTOR RETRACTED) | 39" | 46" | 51" 46" | 51" 46" |
| 55" | Overall Deck Width | 50" | 55" | 60" 55" | 60" 55" |
| 3 | Number of Blades | 2 | 3 | 3 | 3 |
| 1.5" to 4" | Mower Cutting Height Range | 1.5" to 4" | 1.5" to 4" | 1.5" to 3.5" | 1.5" to 3.5" |
| 7 | Mower Cutting Positions | 6 | 6 | 7 | 7 |
| 93 lbs. | Deck Weight | 93 lbs. | 93 lbs. | 140 lbs. 93 lbs. | 140 lbs. 93 lbs. |
| 359 lbs. | Power Unit Weight | 378 lbs. | 378 lbs. | 475 lbs. | 475 lbs. |
| 13 ga. Stamped | Construction | 11 ga. Fab | 13 ga. Stamped | 11 ga. Fab 13 ga. Stamped | 11 ga. Fab 13 ga. Stamped |
| 1" | Spindle | 1" | 1" | 1" | 1" |
| Cast Iron | Hub | Cast Iron | Cast Iron | Cast Iron | Cast Iron |
| Optional | Anti Scalp Wheels | Optional | Optional | Optional Optional | Optional Optional |
| Twin Lever/Swing Out | Steering Control | Twin Lever/Swing Out | Twin Lever/Swing Out | Twin Lever/Swing Out | Twin Lever/Swing Out |
| High Density Foam | Seat Cushion | High Density Foam | High Density Foam | High Density Foam | High Density Foam |
| Vinyl | Seat Cover | Vinyl | Vinyl | Vinyl | Vinyl |
| Standard | Seat Springs | Standard | Standard | Standard | Standard |
| No | Headlights | Standard | Standard | Standard | Standard |
| No | Beverage Holder | Standard | Standard | Standard | Standard |
| Electric | Mower Clutch | Electric | Electric | Electric | Electric |
| 9 x 3.5 x 4 | Tires-Front | 11 x 4 x 5 | 11 x 4 x 5 | 11 x 4.0 x 5 | 11 x 4.0 x 5 |
| 16 x 6.5 x 8 | Tires-Rear | 18 x 6.5 x 8 | 18 x 8.5 x 8 | 18 x 8.5 x 8 | 18 x 8.5 x 8 |
| Zero | Turning Radius | Zero | Zero | Zero | Zero |
| WARRANTY | | | | | |
| 2 Years | Homeowner | 2 Years | 2 Years | 2 Years | 2 Years |
| 90 Days | Commercial | 90 Days | 90 Days | 90 Days | 90 Days |
| ACCESSORIES | | | | | |
| Yes | Mulching Kit | Yes | Yes | Yes Yes | Yes Yes |
| Yes | Grass Blower | Yes | Yes | Yes Yes | Yes Yes |
| Yes | Grass Catcher | Yes | Yes | Yes Yes | Yes Yes |
| Yes | Twin Bag Grass Collector | Yes | Yes | Yes Yes | Yes Yes |
| No | Grass Catcher Cart | No | No | Yes Yes | Yes Yes |
| No | Clam Shell Grass Catcher | No | No | Yes Yes | Yes Yes |
| No | Snow Blower | No | No | No No | No No |
| Yes | Snow Blades | Yes | Yes | Yes Yes | Yes Yes |
| Yes | Wheel Weights/Chains | Yes | Yes | Yes Yes | Yes Yes |

ZTR 4518

PRO

ZTR 1950

ZTR 2300

ZTR 2560

ZTR 2700

| Kohler | | ENGINE | Kawasaki | Kohler | Kohler | Kawasaki |
|---------------------------------|----------------|-----------------------------------------|---------------------------------|---------------------------------|------------------------------------|-----------------------------------------|
| Command Pro | | Type | FH Series | Command Pro | Command Pro | Liquid Cooled - Gas |
| 18 | | Horsepower @ 3600 RPM | 19 | 23 | 25 | 27 |
| 2 | | Cylinders | 2 | 2 | 2 | 2 |
| 672 cc (38.0 cu. in.) | | Displacement cc (cu. in.) | 675 cc (41.2 cu. in.) | 674 cc (41.0 cu. in.) | 725 cc (44.0 cu. in.) | 745 cc (45.5 cu. in.) |
| 77 mm x 67 mm (3.03" x 2.64") | | Bore x Stroke mm (in.) | 75.2 mm x 76 mm (2.9" x 3.0") | 80 mm x 67 mm (3.15" x 2.64") | 83 mm x 67 mm (3.27" x 2.64") | 78 mm x 78 mm (3.07" x 3.07") |
| N/A | | Cast Iron Sleeve | Yes | Yes | Yes | yes |
| 2 qts. | | Oil Capacity | 2 qts. | 2 qts. | 2 qts. | 2.1 qts. |
| Full Pressure Lube | | Lubrication | Full Pressure Lube | Full Pressure Lube | Full Pressure Lube | Full Pressure Lube |
| Disposable Canister | | Oil Filter | Disposable Canister | Disposable Canister | Disposable Canister | Disposable Canister |
| Paper Element w/foam precleaner | | Air Cleaner | Paper Element w/foam precleaner | Paper Element w/foam precleaner | Paper Element w/foam precleaner | Paper Element w/foam precleaner |
| Electronic | | Ignition | Electronic | Electronic | Electronic | Electronic |
| 12 V. w/key & solenoid | | Starter | 12 V. w/key & solenoid | 12 V. w/key & shift solenoid | 12 V. w/key & solenoid | 12 V. w/key & solenoid |
| 15 amp DC regulated | | Electrical System | 13 amp DC regulated | 15 amp DC regulated | 15 amp DC regulated | 20 amp DC regulated |
| Seat/Traction Drive/Mower | | Interlock Safety Switch | Seat/Traction Drive/Mower | Seat/Traction Drive/Mower | Seat/Traction Drive/Mower | Seat/Traction Drive/Mower |
| 12 V. / CCA-340 | | Battery | 12 V. / CCA 260 | 12 V. / CCA 260 | 12 V. / CCA 340 | 12 V. / CCA 525 |
| 2.7 Gal. | | Fuel Tank Capacity | 11.5 Gal. | 11.5 Gal. | 11 Gal. | 11.5 Gal. |
| Solid Mount | | Mounting | Iso Mount | Iso Mount | Solid Mount | Solid Mount |
| TRANSMISSION | | | | | | |
| Hydro Gear | | Make | Hydro-Gear | Hydro-Gear | Hydro-Gear | Hydro-Gear |
| IZT | | Type | BDP-10A Pump | BDP-10A Pump | BDP 10A Pump w/Fan | BDP 10A Pump w/Fan |
| Bevel/Spur Gear | | Final Drive | White Wheel Motor CE 14 | White Wheel Motor CE 14 | White Wheel Motor CE 14 | White Wheel Motor CE 14 |
| 6.5 mph | | Forward Speed | 8 mph | 8 mph | 10 mph | 10 mph |
| Disc | | Park Brake | Drum | Drum | Drum | Drum |
| OTHER FEATURES | | | | | | |
| 50" | 42" | Deck Cut Width | 50" | 60" 50" | 60" | 60" 72" |
| 51" | 46" | Deck Width (DEFLECTOR RETRACTED) | 51" | 63" 51" | 62.5" | 62.5" 74.5" |
| 60" | 55" | Overall Deck Width | 60" | 73" 60" | 73.5" | 73.5" 85.5" |
| 3 | | Number of Blades | 3 | 3 | 3 | 3 |
| 1.5" to 3.5" | | Mower Cutting Height Range | 1.5" to 4.5" | 1.5" to 4.5" | 1.5" to 5" | 1.5" to 6" |
| 7 | | Mower Cutting Positions | 7 | 7 | 10 | 10 |
| 140 lbs. | 93 lbs. | Deck Weight | 140 lbs. | 173 lbs. 140 lbs. | 231 lbs. | 231 lbs. 261 lbs. |
| 478 lbs. | | Power Unit Weight | 597 lbs. | 597 lbs. | 886 lbs. | 900 |
| 11 ga. Fab | 13 ga. Stamped | Construction | 11 ga. Fab | 10 ga. Stamped 11 ga. Fab | 10 ga. Steel w/7 ga. Reinforcement | 10 ga. Steel Tube w/7 ga. Reinforcement |
| 1" | | Spindle | 1" | 1" | 25 mm (0.984") | 25 mm (0.984") |
| Cast Iron | | Hub | Cast Iron | Cast Iron | Cast Iron | Cast Iron |
| Optional | Optional | Anti Scalp Wheels | Optional | Standard Optional | Standard | Standard |
| Twin Lever/Swing Out | | Steering Control | Twin Lever/Swing Out | Twin Lever/Swing Out | Twin Lever/Swing Out | Twin Lever/Swing Out |
| High Density Foam | | Seat Cushion | High Density Foam w/suspension | High Density Foam w/suspension | High Density Foam | High Density Foam w/suspension |
| Vinyl | | Seat Cover | Cordura | Cordura | Cordura | Vinyl |
| Standard | | Seat Springs | Standard | Standard | Standard | Standard |
| Standard | | Headlights | No | No | No | No |
| Standard | | Beverage Holder | Standard | Standard | No | Standard |
| Electric | | Mower Clutch | Electric | Electric | Electric | Electric |
| 11 x 4.0 x 5 | | Tires-Front | 11 x 4.0 x 5 | 11 x 4.0 x 5 | 13 x 5.0 x 6 | 13 x 6.5 x 6 |
| 18 x 8.5 x 8 | | Tires-Rear | 20 x 10 x 8 | 20 x 10 x 8 | 23 x 9.5 x 12 | 23 x 10.5 x 12 |
| Zero | | Turning Radius | Zero | Zero | Zero | Zero |
| WARRANTY | | | | | | |
| 2 Years | | Homeowner | 2 Years | 2 Years | 2 Years | 3 Years |
| 90 Days | | Commercial | 1 year/400 hours | 1 year/400 hours | 1 year/400 hours | 1 year/750hours |
| ACCESSORIES | | | | | | |
| Yes | Yes | Mulching Kit | Yes | 60" 50" Yes | Yes | No |
| Yes | Yes | Grass Blower | Yes | No Yes | Yes | No |
| Yes | Yes | Grass Catcher | Yes | No Yes | Mounted solid container | No |
| Yes | Yes | Twin Bag Grass Collector | Yes | No Yes | No | No |
| Yes | Yes | Grass Catcher Cart | Yes | No Yes | No | No |
| Yes | Yes | Clam Shell Grass Catcher | Yes | No Yes | No | No |
| No | No | Snow Blower | Yes | Yes | Yes | No |
| Yes | Yes | Snow Blades | Yes | Yes | Yes | Yes |
| Yes | Yes | Wheel Weights/Chains | Yes | Yes | No | No |
| | | Canopy | No | No | No | Yes |
| | | ROPS | No | No | No | Yes |



ZEETER



ZEETER HL

SUBURBAN



SPEEDZTR



ZTR 4515/4516
4518



PRO 1950 / 2300



PRO 2560

ESTATE

All Dixon® ZTR® Mowers are covered by...



More than just helping you choose the right mower, your dealer can also help make it amazingly affordable.

Ask him about on-the-spot financing with Dixon Blue Line Credit. (Our terms are as easy to handle as our mowers!)

You can take your new Dixon ZTR home today, and have your yard mowed before dark.



PRO 2700

PRO



ZTR® Mowers

®Dixon and ®Oregon, are Premier Brands of the Outdoor Products Group of Blount, Inc.

Dixon Industries, Inc.
A **BLOUNT** International, Inc. Company
PO Box 1569, Coffeyville, KS 67337-0945
620-251-2000
toll free 800-264-6075
www.dixon-ztr.com

©Dixon, ZTR and Dixon Estate are registered trademarks of Dixon Industries, Inc
© Dixon Industries, Inc., 8/03

Moore Sales Co.
NW Corner of Square
Lincoln, AR 72744
(479)824-4363 (479)267-4834